

Batería Ciclo Profundo 12V 100 Ah

● Especificaciones

Voltaje Nominal		12V
Capacidad Nominal (índice de 20 horas)		100Ah
Dimensiones	Largo	330 ± 2 mm
	Ancho	171 ± 2mm
	Altura	214 ± 2mm
	Altura Total	220 ± 2mm
Peso Aproximado		30.5kg(67.2lbs)±3%

● Dimensiones Externas (mm)

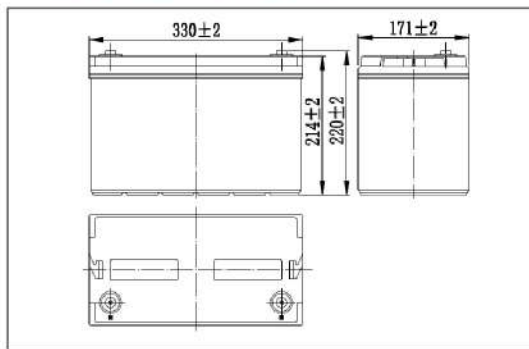

● Tipo de Terminal (mm)

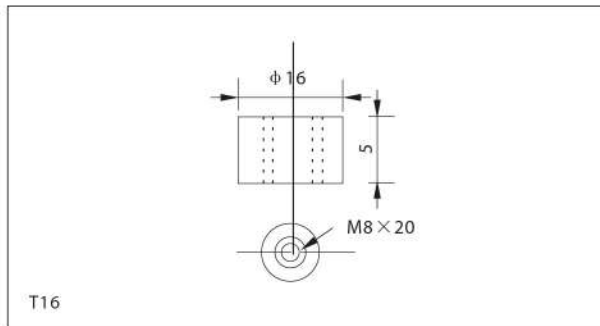

● Construcción

Componente	Placa Positiva	Placa Negativa	Contenedor	Cubierta	Separador	Electrólito	Válvula de Seguridad	Terminal
Materia Prima	Dióxido de Plomo	Plomo	ABS	ABS	AGM	Ácido sulfúrico	Caucho	Cobre

● Características de descarga de corriente constante : A (25 °C, 77 °F)

FV / Time	10 min	15 min	30 min	60 min	2 h	3 h	4 h	5 h	8h	10 h	20 h
9.60V	222	171	103	63.0	37.3	26.8	21.4	18.3	12.6	10.4	5.50
9.90V	216	167	100	62.1	37.1	26.7	21.3	18.2	12.5	10.4	5.49
10.2V	207	161	97.4	60.5	36.7	26.5	21.2	18.1	12.4	10.3	5.48
10.5V	198	156	95.0	58.6	36.2	26.3	21.0	18.0	12.3	10.3	5.44
10.8V	187	147	91.5	56.7	35.3	25.5	20.4	17.4	12.0	10.2	5.41

● Características de descarga de potencia constante : W (25 °C, 77 °F)

FV / Time	10 min	15 min	30 min	60 min	2 h	3 h	4 h	5 h	8 h	10 h	20 h
9.60V	2401	1882	1150	719	432	316	252	216	150	124	66.0
9.90V	2329	1836	1127	708	429	314	251	215	149	124	65.9
10.2V	2233	1769	1093	690	425	312	249	214	148	123	65.7
10.5V	2137	1708	1066	668	419	309	247	212	147	123	65.3
10.8V	2017	1618	1027	647	408	300	240	206	142	122	64.9

●Nota: Los datos de características anteriores pueden obtenerse dentro de tres ciclos de carga o descarga.



● Características

Capacidad (25 °C)	10 HR (10.8 V)	100 Ah
	3 HR (10.8V)	76.5 Ah
	1 HR (10.5 V)	56 Ah
Tipo de Terminal		T 16
Resistencia Interna Carga Completa (25 °C)		Aprox. 4.5m Ω
Capacidad afectada por la temperatura (10 HR)	40 °C	102%
	25 °C	100%
	0 °C	85%
	-15 °C	65%
Auto descarga (25°C)	3 Meses	Capacidad Restante : 91%
	6 Meses	Capacidad Restante : 82%
	12 Meses	Capacidad Restante : 65%
Temperatura Nominal de Funcionamiento		25°C ± 3 °C (77 °F ± 5°F)
Rango de Temperatura de Funcionamiento	Descarga	-15 °C~-50 °C (5 °F ~122 °F)
	Carga	-10 °C~-50 °C (14°F ~122 °F)
	Almacenamiento	-20 °C ~-50 °C (-4 °F~ 122 °F)
Tensión de Carga de Mantenimiento (25 °C)		13.50 to 13.80V Compensación de Temperatura : -18 mV/°C
Voltaje de carga cíclico (25 °C)		14.50 to 15.00 V Compensación de Temperatura: - 30 mV/°C
Corriente de Carga Máxima		30 A
Corriente de Descarga Máxima		800 A (5 sec.)
Vida Flotante Diseñada(20°C)		10 años

● Características de descarga (25°C)

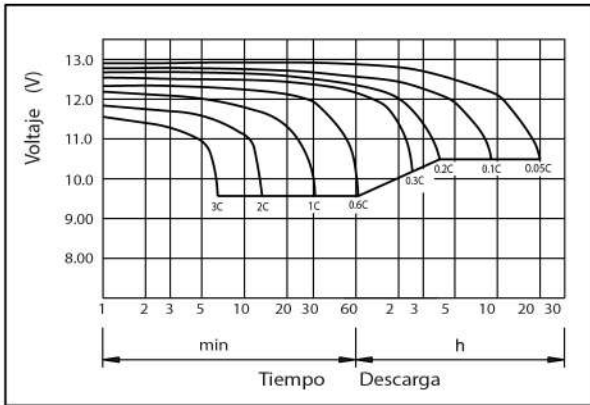

● Características de Carga (25°C)

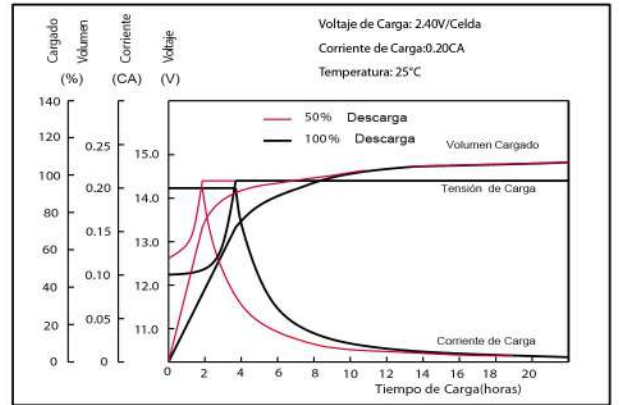

● Efectos de temperatura en la capacidad

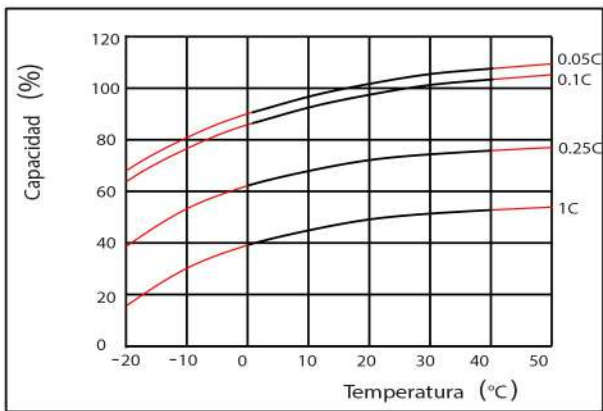

● Características de autodescarga

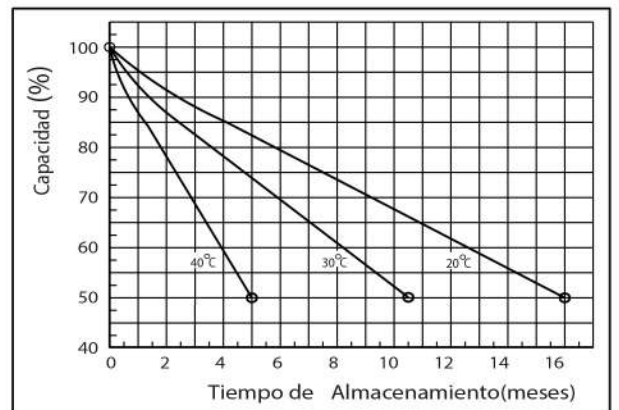

● Vida flotante en la temperatura

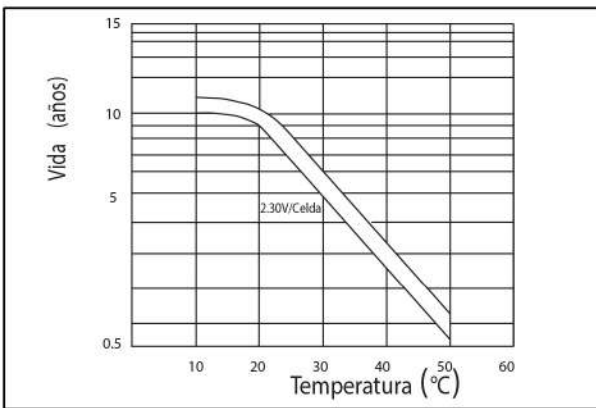

● Ciclo de vida en D.O.D (25°C)

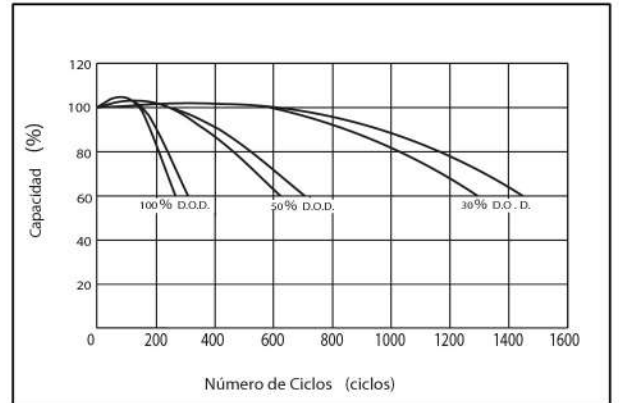

● La relación para OCV y Capacidad (25°C)

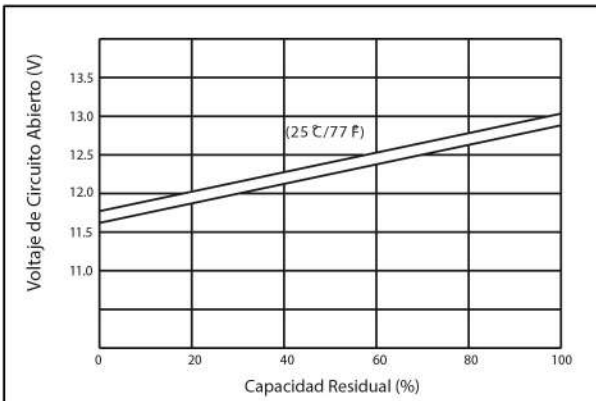

● La relación de voltaje de carga y temperatura

